

Stroke	L
100	245
150	295
200	345
250	395
300	445
350	495
400	545
500	645
600	745
700	845
800	945
900	1045
1000	1145

Stroke	JC
0~250	150
251~400	195
401~630	265
631~1000	375

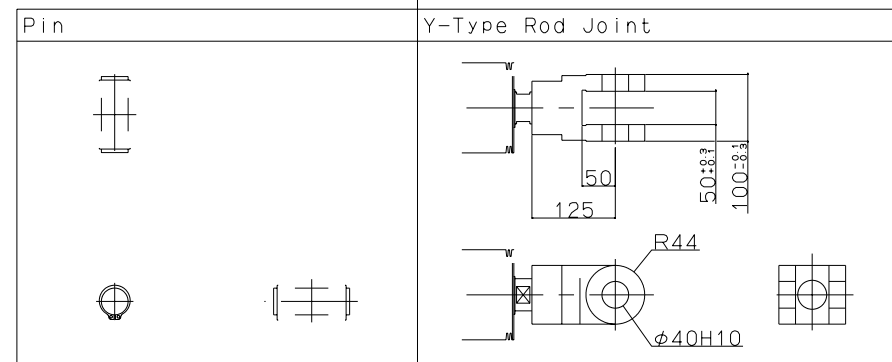

Pin

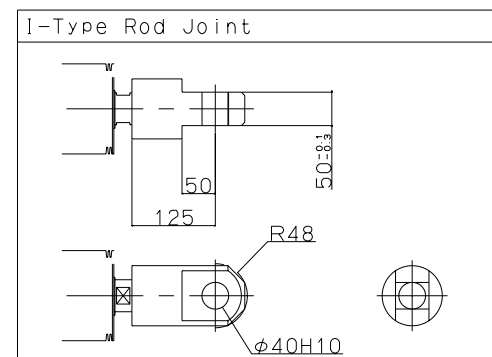
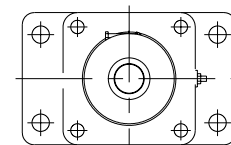
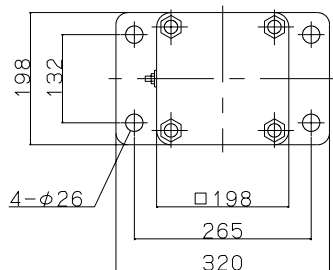
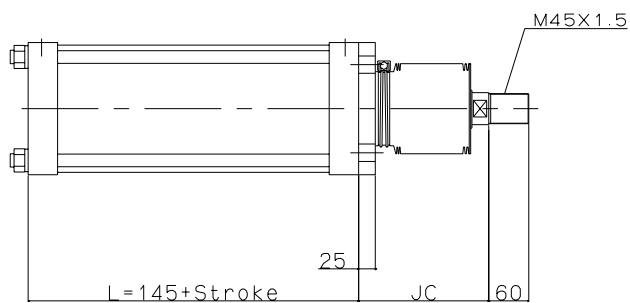
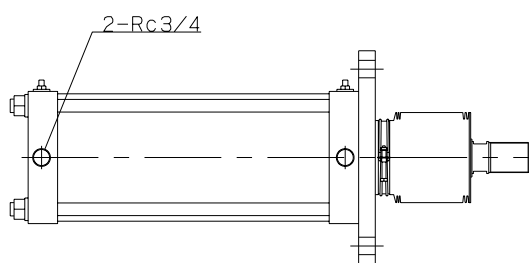
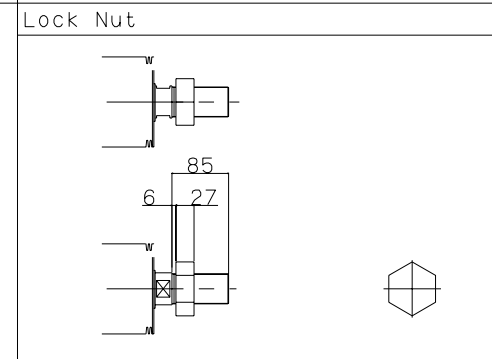

Lock Nut

JIS Symbol

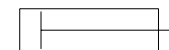

Model:  
 CP611-A(B)(D)-FA-180X350  
 CP611H-A(B)(D)-FA-180X350  
 CP611S2-A(B)(D)-FA-180X350  
 CP611S2H-A(B)(D)-FA-180X350  
 CP665-A(B)(D)-FA-180X350

Maker: KONAN

File Name: CP61-A-FA-180