

Stroke	L
100	260
150	310
200	360
250	410
300	460
350	510
400	560
500	660
600	760
700	860
800	960
900	1060
1000	1160

Stroke	JC
0~250	140
251~400	173
401~630	227
631~1000	311

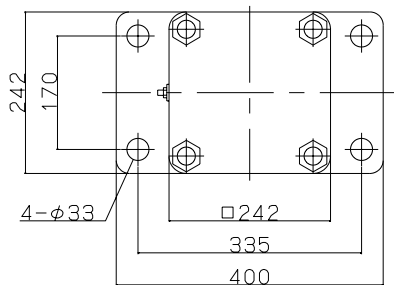

Pin

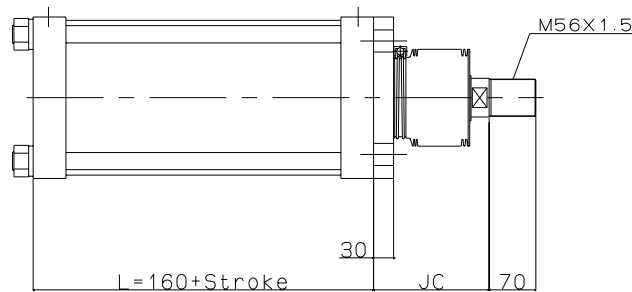
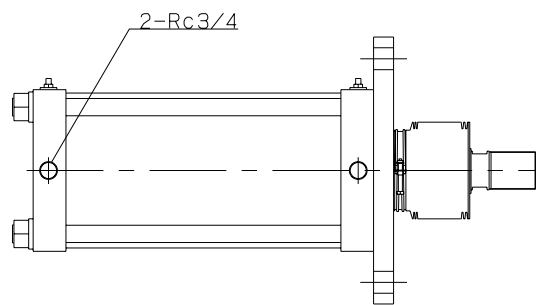
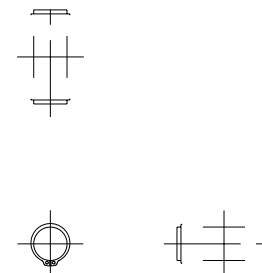

I-Type Rod Joint

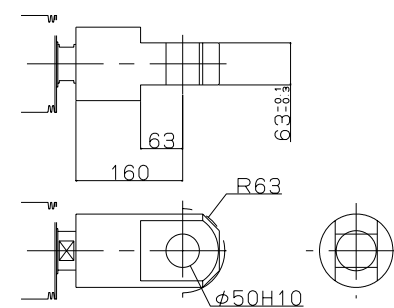

Y-Type Rod Joint

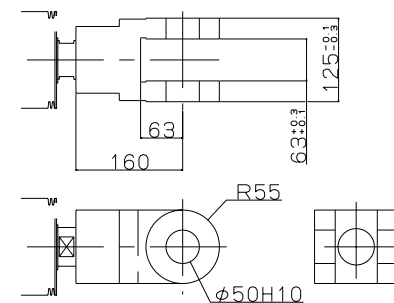

Lock Nut

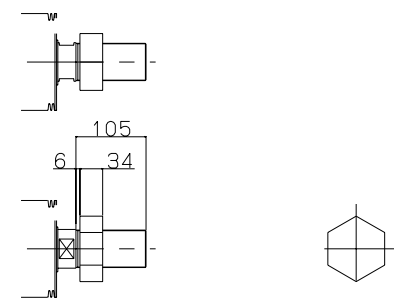

JIS Symbol

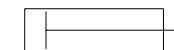

Model:
 CP611-A(B)(D)-FA-220X350
 CP611H-A(B)(D)-FA-220X350
 CP611S2-A(B)(D)-FA-220X350
 CP611S2H-A(B)(D)-FA-220X350
 CP665-A(B)(D)-FA-220X350

Maker: KONAN

File Name: CP61-A-FA-220