

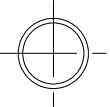

Port Size	
Rc1/4(8A)	Rc3/8(10A)
	

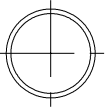
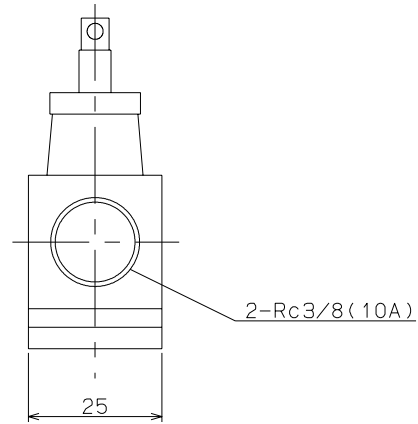
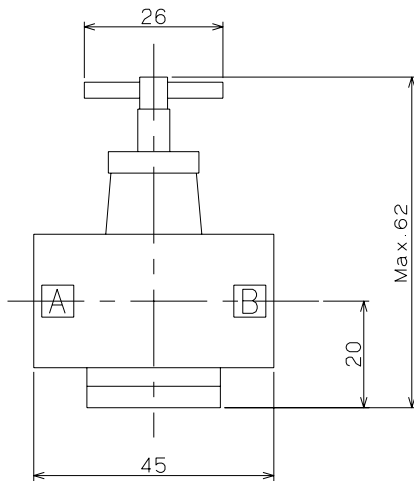
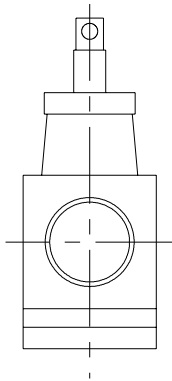
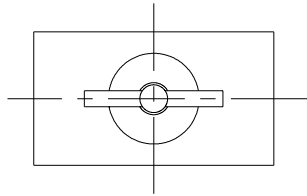

JIS Symbol 	Model:	SC6-02-8A.10A SC6S-02-8A.10A SC6F-02-10A
	Maker:	KONAN
	File Name:	SC6-02