

Port Size
302: Rc1/4 (8A)
303: Rc3/8 (10A)

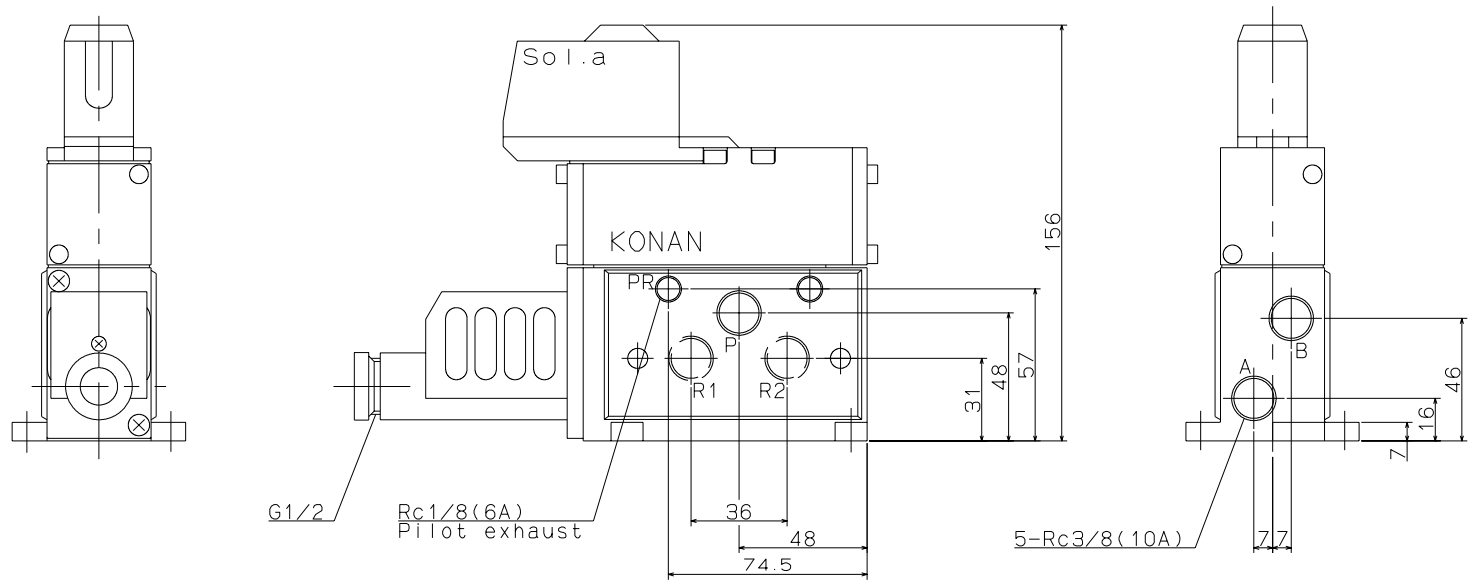

JIS Symbol
Model :
416S302F-Yi 414S302F-Yi 416S303F-Yi 414S303F-Yi 416S302C-Yi 414S302C-Yi 416S303C-Yi 414S303C-Yi 416S302G-Yi 414S302G-Yi 416S303G-Yi 414S303G-Yi 416S302M-Yi 414S302M-Yi 416S303M-Yi 414S303M-Yi
Maker :
KONAN
File Name :
414S303C-YI