

Port size
403:Rc3/8(10A)
404:Rc1/2(15A)

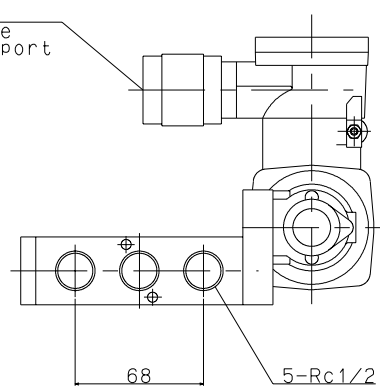
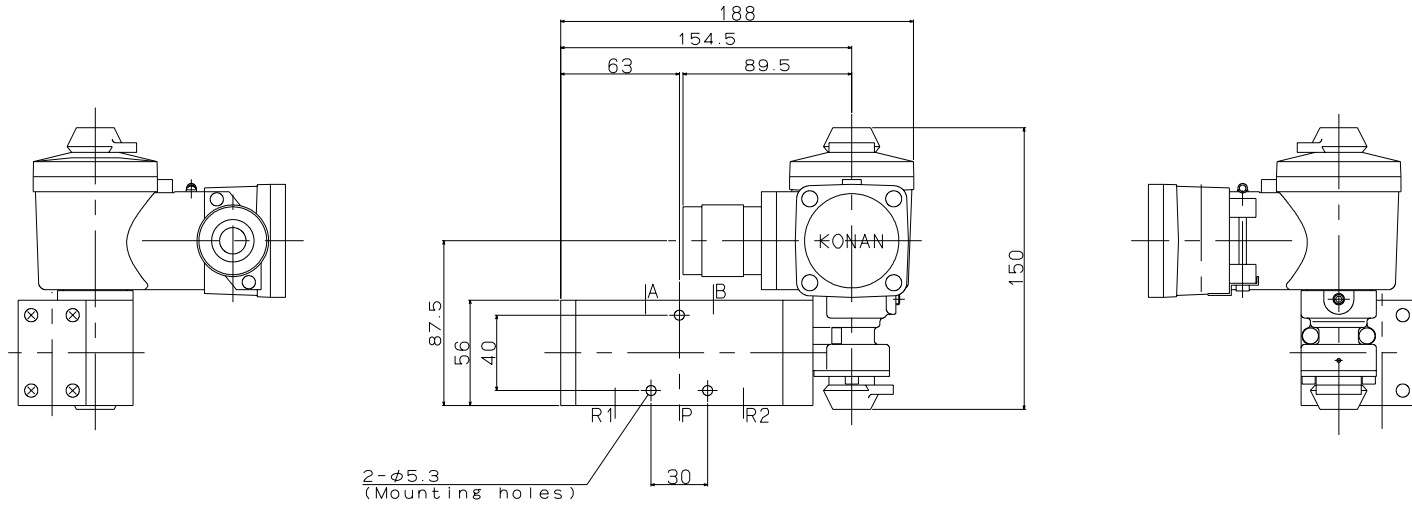
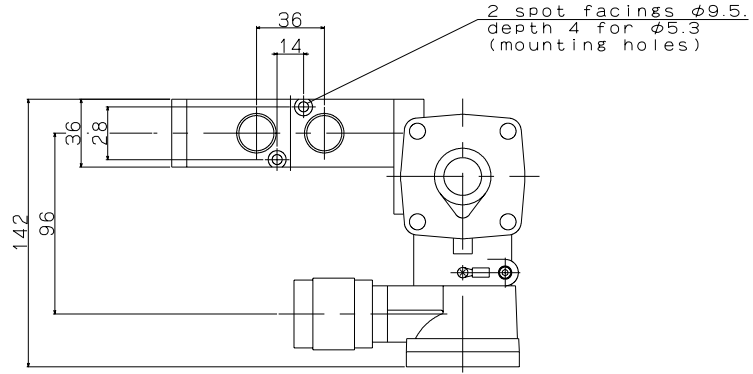

	Model:	453D403C-E2K
		453D404C-E2K
	Maker:	KONAN
	File Name:	453D404C-E2K