

Port size
403:Rc3/8(10A)
404:Rc1/2(15A)

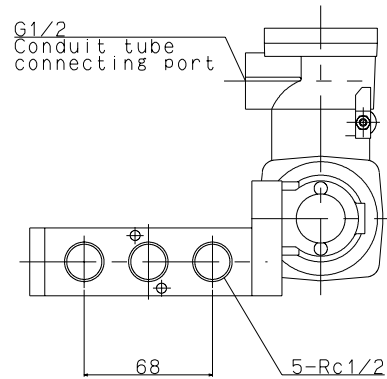
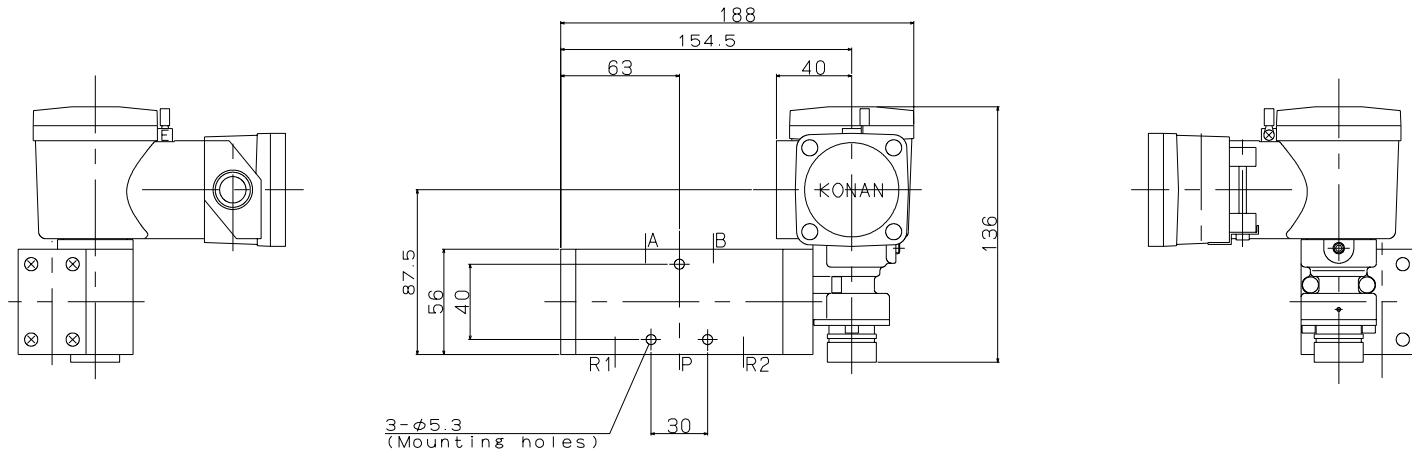
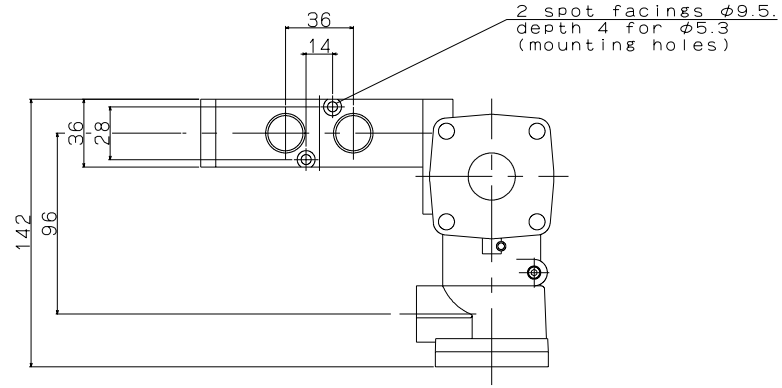

	Model :	453S403C-E1K
		453S404C-E1K
	Maker :	KONAN
	File Name :	453S404C-E1K