

Port size 20A (Rc3/4)
25A (Rc1)

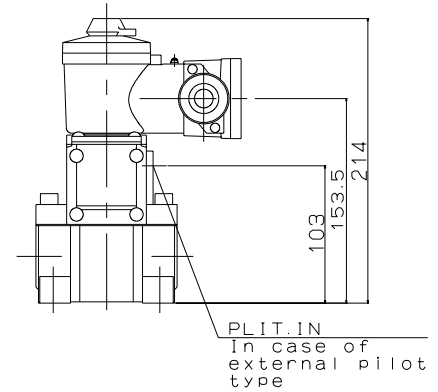
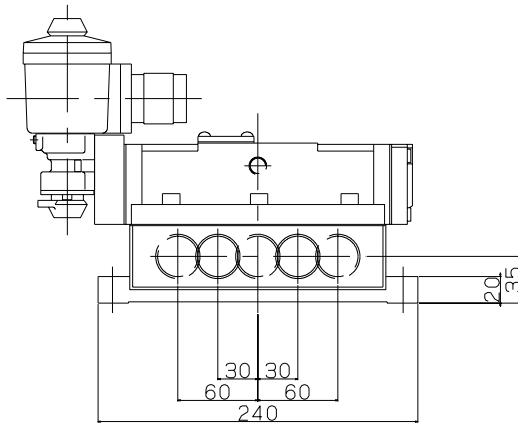
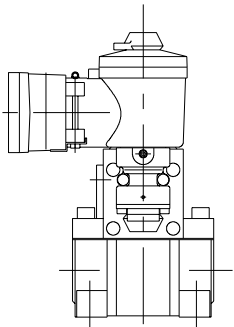
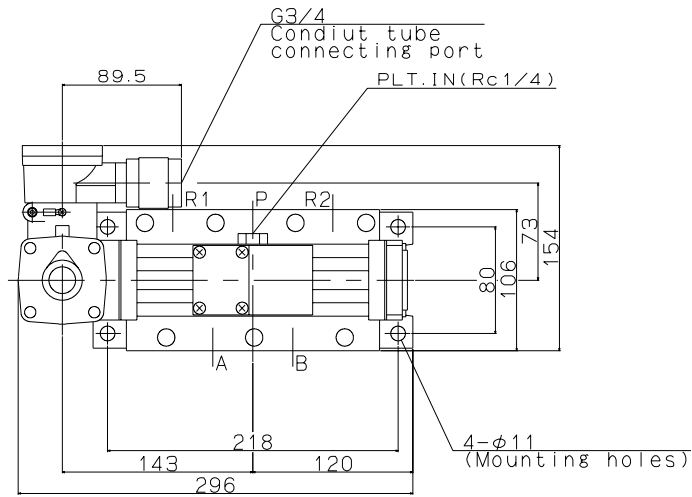

JIS Symbol	Model: MVD2N-08-E2K-20A.25A
	Maker: KONAN
	File Name: MVD2N-08-E2K