

Port Size	
Rc1 · 1/4 (32A)	Rc1 · 1/2 (40A)

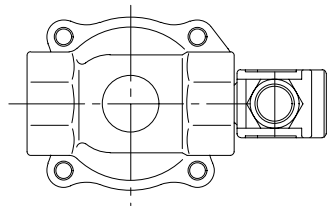
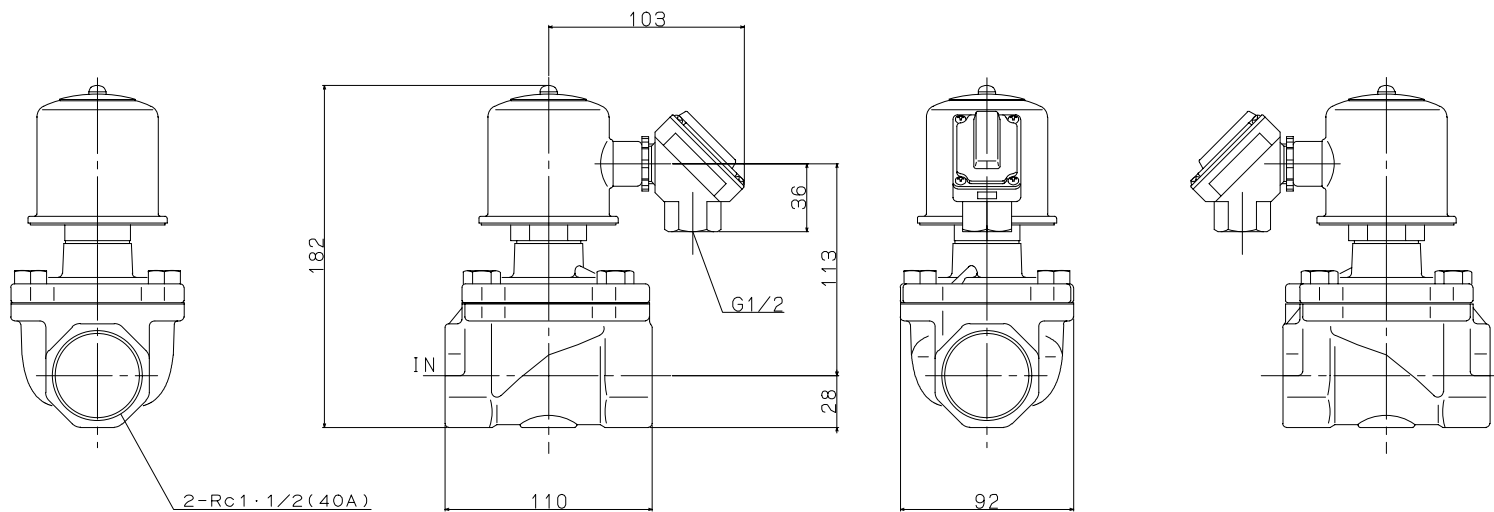

JIS Symbol	
Model :	*S271G****G** *S271G****H**
Maker :	KONAN
File Name :	YS271GH