

Port Size	
Rc1 · 1/4 (32A)	Rc1 · 1/2 (40A)

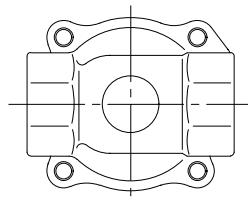
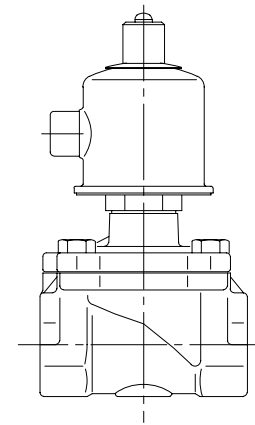
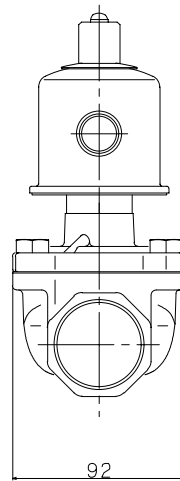
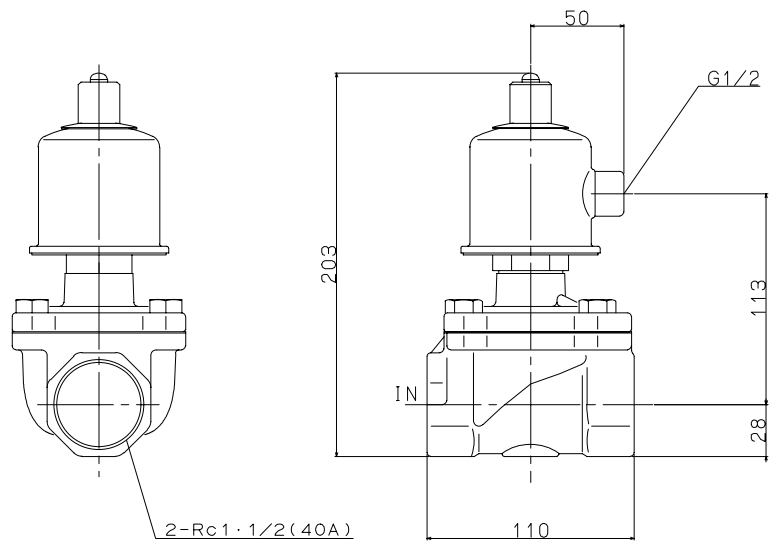

JIS Symbol	
Model :	*S272W****G** *S272W****H**
Maker :	KONAN
File Name :	YS272WH