

Port Size
302: Rc 1/4 (8A)
303: Rc 3/8 (10A)

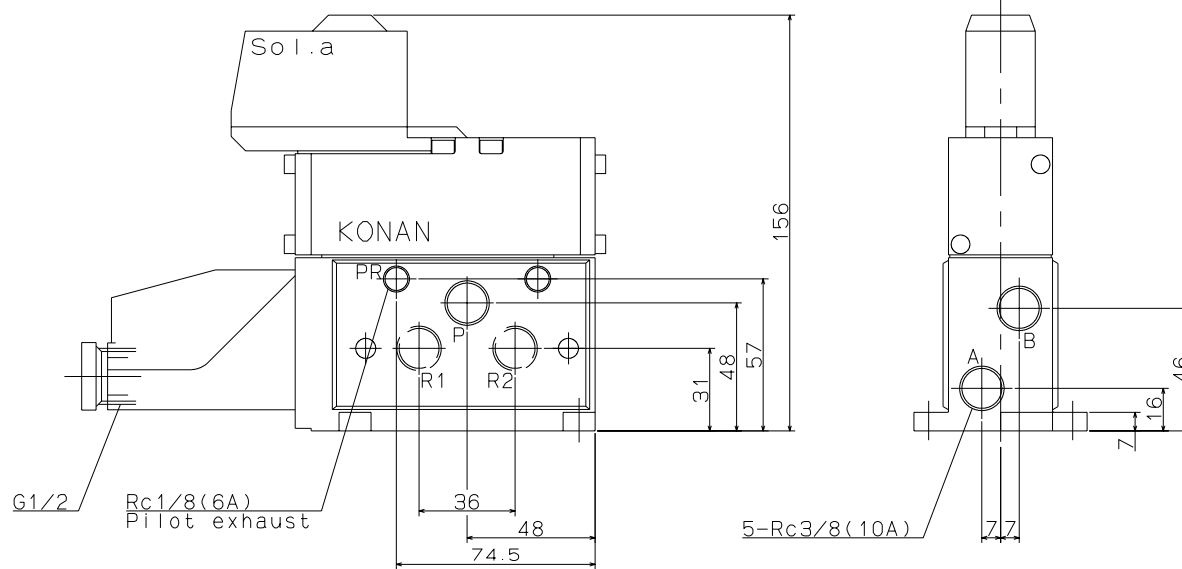
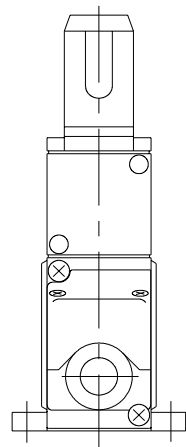

JIS Symbol
Model :
416S302E-ZA 414S302C-ZA
416S303E-ZA 414S303C-ZA
416S302F-YAi 414S302F-YAi
416S303F-YAi 414S303F-YAi
416S302G-YAi 414S302G-YAi
416S303G-YAi 414S303G-YAi
416S302M-YAi 414S302M-YAi
416S303M-YAi 414S303M-YAi
Maker :
KONAN
File Name :
414S303C-ZA